

April 2013

## Power Theft Prevention and Power Quality Improvement using Fuzzy Logic

Sriram Rengarajan

*Electrical and Electronics Engineering, Sri Sairam Engineering College, Chennai, India,*  
sriram.rengarajan92@gmail.com

Shumuganathan Loganathan

*Electrical and Electronics Engineering, Sri Sairam Engineering College, Chennai, India,*  
shumu1992@gmail.com

Follow this and additional works at: <https://www.interscience.in/ijeee>



Part of the [Power and Energy Commons](#)

---

### Recommended Citation

Rengarajan, Sriram and Loganathan, Shumuganathan (2013) "Power Theft Prevention and Power Quality Improvement using Fuzzy Logic," *International Journal of Electronics and Electrical Engineering*: Vol. 1 : Iss. 4 , Article 10.

Available at: <https://www.interscience.in/ijeee/vol1/iss4/10>

This Article is brought to you for free and open access by Interscience Research Network. It has been accepted for inclusion in International Journal of Electronics and Electrical Engineering by an authorized editor of Interscience Research Network. For more information, please contact [sritampatnaik@gmail.com](mailto:sritampatnaik@gmail.com).

# Power Theft Prevention and Power Quality Improvement using Fuzzy Logic

Sriram Rengarajan & Shumuganathan Loganathan

Electrical and Electronics Engineering, Sri Sairam Engineering College, Chennai, India  
E-mail : sriram.rengarajan92@gmail.com, shumu1992@gmail.com

---

**Abstract** - This paper deals with Fuzzy logic based power theft prevention and power quality improvement. It involves comparison between the total load supplied by the distribution transformer and the total load used by the consumer and the error signal is used to identify the power theft. Load (energy) and voltage are fed as input to the Fuzzy logic controller and the corresponding change in output voltage is provided by the controller to improve the power quality and to prevent the power theft. Simulations are done using MATLAB and the results of the simulations are provided. It helps us to analyze the efficiency of intelligent control in electrical systems.

**Keywords** - fuzzy logic, fuzzy controller, power theft, power quality, intelligent control.

---

## I. INTRODUCTION

Intelligent control in electrical systems can be used to improve its quality and to prevent lot of mischief which are happening in the present transmission and distribution. One of the important mischief is the power theft which is contributing a larger amount to the non-technical losses in transmission and distribution. In US, the consensus seems to be that theft costs between 0.5% and 3.5% of annual gross revenues. In developing countries like India, theft contributes about 35% loss to the country.

### A. Defining Power Theft:

Two kinds of theft are prevalent in power systems. First one is the Meter tampering and the second one is the direct rigging of the distribution line. Meter tampering is the method of tampering the meter by removing its seal or by by-passing the meter so that a lower reading of power use is shown in this case. In this case the meter can also be tampered and used by some other person and the owner of the meter has to pay for the power used by some other person. But the prevention of power theft of this type can be detected by placing a LDR circuit inside the meter so that it sends the warning signal to the sub-station as soon as the meter is tampered. So this kind of power theft is not a major problem. But the second case of power theft is a major problem. Here we cannot identify the power theft automatically and it contributes a great loss to the government. This kind of Power theft can be prevented by using Fuzzy logic in distribution systems.

### B. Defining Power Quality:

Power quality is the set of electrical limits that allows electrical systems to function in their intended manner without significant loss of performance or life. The quality of electrical power may be described as a set of values of parameters such as continuity of service, variation in voltage magnitude, transient voltages and currents, harmonic content in the waveforms. Over-voltage, Under-voltage, surge, sag, non-zero low frequency impedance, non-zero high frequency impedance are the common problems which degrade power quality. we can rectify these power quality problems using fuzzy logic. While power quality is a convenient term for many, it is the quality of voltage which is supplied to the consumers rather than current or power. Power quality is an issue that is becoming increasingly important to electricity consumers at all levels of usage. Sensitive power electronic equipment and non-linear loads are widely used in industrial, commercial and domestic applications leading to distortion in voltage and current waveforms. Improvement of PQ has a positive impact on sustained profitability of the distribution utility on the one hand and customer satisfaction on the other.

## II. PRINCIPLE OF PREVENTING POWER THEFT

The basic working principle of this system is the comparison of the total load (energy) supplied by the distribution transformer and the total load used by the

consumers connected to that transformer as shown in the block diagram(below).An electronic energy meter with GSM modem is placed at each of the consumer terminal. It measures the total load(energy) used by the consumers and it transfers to the substation. It is compared with the energy meter reading of the electronic meter placed at the distribution transformer. If both the values are same, then there is no problem(neglecting the losses in transmission and distribution). However if the value of the transformer energy meter reading is greater than the consumer’s meter reading, then it is the case of power theft. Using this error signal we can detect the power theft. This error signal is sent to the fuzzy logic controller and it reduces the secondary voltage of the distribution transformer to a critical value so that the relay circuit in the transformer becomes opened and the supply from the transformer comes to a halt. The reduction in voltage level is achieved by using a tap changer circuit. The output of FLC is connected to the tap changer circuit and it changes the tappings of secondary of transformer so that the reduction in voltage level is achieved.

### III. PRINCIPLE OF IMPROVING POWER QUALITY

The difference between the actual voltage and the nominal voltage is fed as the input to the FLC. For example, the nominal voltage may be 230V or it may be 120V. If the difference is zero, then actual voltage is equal to the nominal voltage and there is no problem in power quality. If the difference is negative, then it’s the case of under-voltage. If the difference is positive, then it’s the case of over-voltage. We can also detect short-circuit problems and over-load problems using this principle. The FLC makes the corresponding change in output voltage depending upon it’s input. For example, if it is under-voltage then the Corresponding change in output will be to increase the input voltage.

Fig. 1: Block diagram of power theft prevention using fuzzy controller

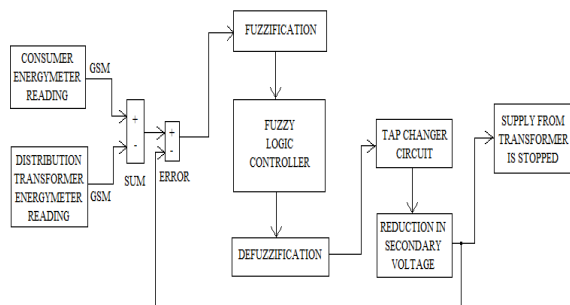

#### A. Crisp inputs:

The crisp inputs to the system are load and voltage where load and voltage are defined as follows:

$$\text{LOAD} = (\text{TRANSFORMER LOAD}) - (\text{CONSUMER LOAD})$$

$$\text{VOLTAGE} = (\text{ACTUAL VOLTAGE}) - (\text{NOMINAL VOLTAGE})$$

#### B. Fuzzy inputs:

The crisp inputs are changed into fuzzy inputs by defining membership functions (mf) for each crisp input. The membership function for input voltage is as follows:

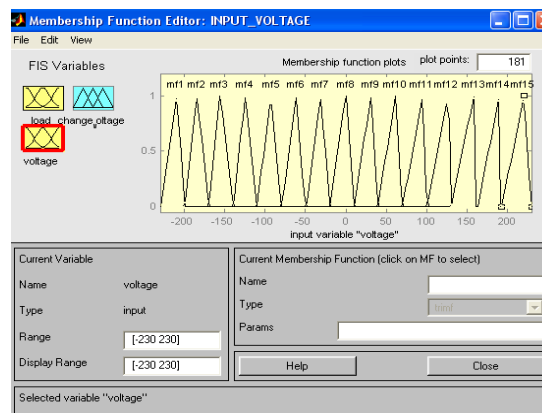

Here the voltage range is from [-230,230] (230V is chosen as the nominal value) .There are 15 membership functions defined for the input voltage. These 15 mfs maps the crisp input voltage into fuzzy inputs (it maps into the range [0,1])

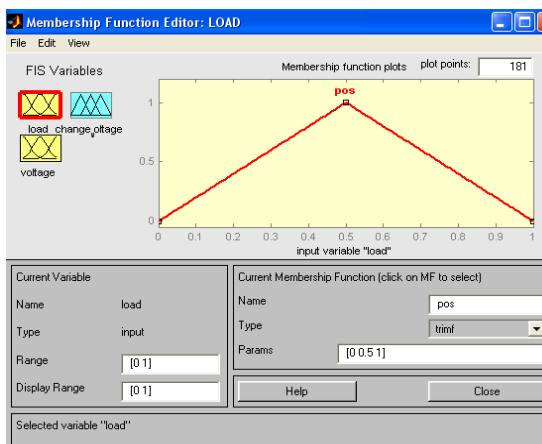

The membership function of “change voltage”(output)is same as that of input voltage because the change in output voltage depends upon the input voltage for power quality improvement. For example, if the actual voltage is 180V, then the input voltage will be -50V and the change voltage will be +50V.If the load value is positive, then the change voltage goes below the critical value irrespective of the input voltage value.

Thus all the crisp inputs are changed into fuzzy inputs successfully.

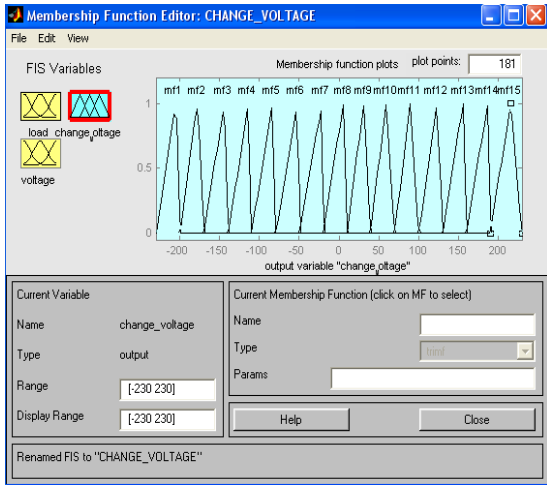

C. Fuzzification method:

The method of fuzzification used is “mamdani”. The membership functions are triangular. They are not symmetrical. (that is the interval occupied by each mf may vary). For example, in the membership functions shown above for input voltage and change voltage, the mf15 is slightly broader than the other mfs.

D. Control rules:

If the load (in MW) becomes positive, then it’s the case of power theft. Therefore the rule for prevention of power theft is as follows:

If the load is positive, then change voltage is mf1

Therefore the secondary voltage becomes very low so that the relay in secondary will open and the supply is stopped.

The rule for power quality depends upon the input voltage and the load. If the load is zero, then it is the normal functioning of the power system and there is no power theft. Therefore the improvement in power quality is done only for normal functioning of the power system. Here each mf of input voltage and change voltage covers an average of 30V (interval can be changed depending upon the level of accuracy needed). Therefore there are 15Mfs for the input voltage and change voltage in the range[-230,230].

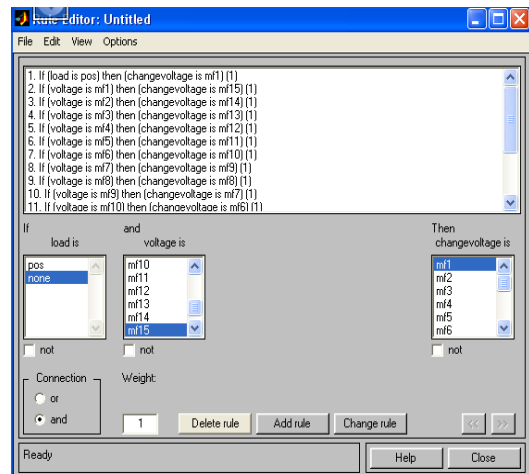

**RULE TABLE for fuzzy controller**

VOLTAGE $V_i$	mf1	mf2	mf3	mf4	mf5	mf6	mf7	mf8	mf9	mf10	mf11	mf12	mf13	mf14	mf15
LOAD $L_i$															
pos	mf1	mf1	mf1	mf1	mf1	mf1	mf1	mf1	mf1	mf1	mf1	mf1	mf1	mf1	mf1
zero	mf15	mf14	mf13	mf12	mf11	mf10	mf9	mf8	mf7	mf6	mf5	mf4	mf3	mf2	mf1

From the rule table one of the rules for improving power quality as follows:

“If the load ( $L_i$ ) is zero and the voltage( $V_i$ ) is mf13 then change voltage is mf3”. This is the case of over-voltage. Similarly other rules can be framed from the rule table.

The surface rule view of the above rules of the fuzzy inference is

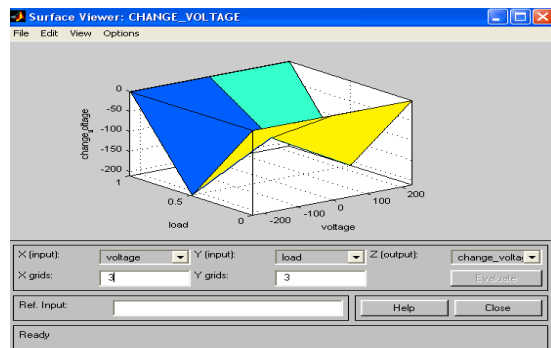
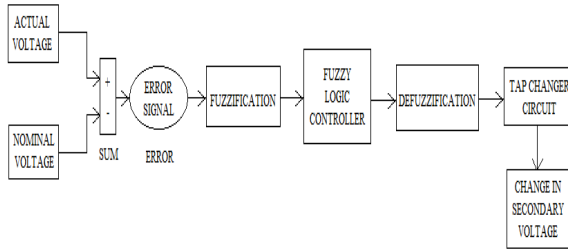

Fig.2. Block diagram of power quality improvement using fuzzy controller



**E. Defuzzification:**

The method of Defuzzification used is “centroid” method. The output of the defuzzified value is given to the tap changer circuit.

**F. Tap changer:**

The voltage control is performed by changing the turns ratio. This is done by provision of taps in the winding. The volts per turn available in large transformers is quite high and hence a change of even one turn on the LV side represents a large percentage change in the voltage. Changer is used. LV winding being the inner winding in a core type transformer adds to the difficulty of taking out of the taps. Hence irrespective of the end use for which tapping is put to, taps are provided on the HV winding. Provision of taps to control voltage is called tap changing. Tap changers are classified to off-load tap changer and on-load tap changer. For many power transformer applications on-load tap-changer is used. The on-load tap changer is installed in the primary side of a power transformer to select or adjust voltage. The advantage of this is for solving the voltage drop issues in the secondary output in the farthest location

**IV. MATLAB RESULTS:**

*Result of Over-Voltage :* If the voltage is 151V then the change voltage is -151V

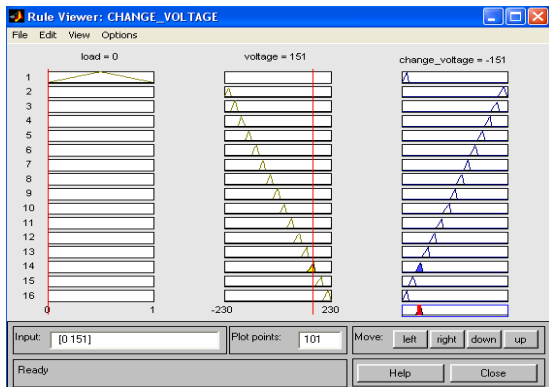

*Result of Normal functioning:* If the voltage is 230V then the change voltage is 0V.

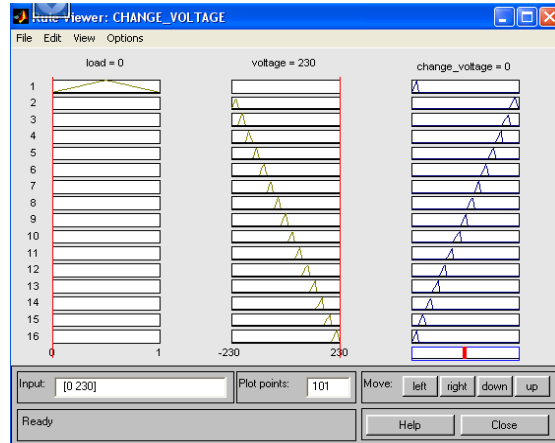

*Result of Power Theft:* Voltage is brought down below the critical value in case of power theft.

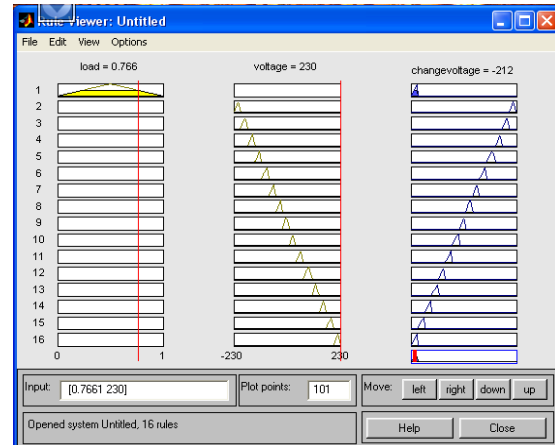

*Result of Under-Voltage:* If the voltage is -55.8V then the change voltage is 55.7V

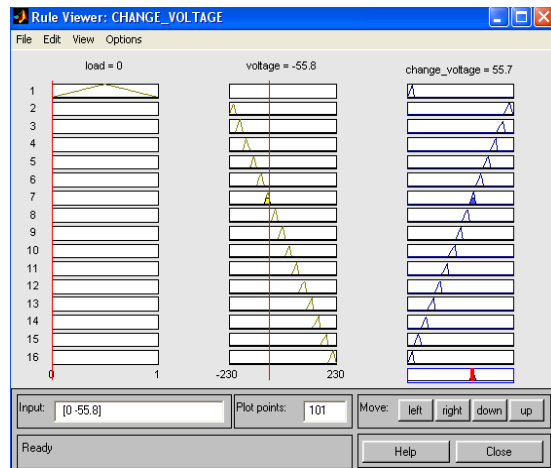

From the MATLAB results shown, the changes are made corresponding to the error encountered by the fuzzy logic controller

## V. CONCLUSION

Thus, the application of intelligent control in electrical system can improve the power quality to a great extent, at the same time it can prevent a lot of illegal activities. India loses about INR 40,000 Crores (35%) annually, South Africa loses about 4.4 billion RND annually – all because of power theft. Thus, the economy of the power system is increased leading to increase in economy of the country. The power theft prevention will be a boon to a country's economy in managing the need for power generation. Improving quality in power is indeed an important requirement for our future. Hence this establishment of automatic intelligence in power systems will be a great improvement.

## REFERENCES

- [1] Vinod Kumar and R.R.Joshi, "Hybrid Controller based Intelligent Speed Control of Induction Motor", *Journal of Theoretical and Applied Information Technology* © 2005.
- [2] Nasri Sulaiman, M. H. Marhaban and M. N. Hamidon, "FPGA-Based Fuzzy Logic: Design and Applications – a Review", *IACSIT International Journal of Engineering and Technology*, Vol.1, No.5, December, 2009, ISSN: 1793-8236.
- [3] A. Rajagopalan, G. Washington, G. Rizzoni, and Y. Guezennec, "Development of Fuzzy Logic and Neural Network Control and Advanced Emissions Modeling for Parallel Hybrid Vehicles, December 2003. NREL/SR-540-32919
- [4] *Fuzzy Logic Toolbox For Use with MATLAB®, User's Guide Version 2, The Math Works*

