

October 2011

Influence of Nanoparticle Shape Factor on Convective Heat Transfer of Water-Based ZnO Nanofluids. Performance Evaluation Criterion

S. Ferrouillat

LEGI, Joseph Fourier University, Grenoble, France, Sebastien.ferrouillat@ujf-grenoble.fr

A. Bontemps

LEGI, Joseph Fourier University, Grenoble, France, A.Bontemps@gmail.com

O. Poncelet

5LITEN/DTS/LETh, CEA, Grenoble, France, O.Poncelet@gmail.com

J. A. Gruss

5LITEN/DTS/LETh, CEA, Grenoble, France, Jean-Antoine.Gruss@cea.fr

O. Soriano

5LITEN/DTS/LETh, CEA, Grenoble, France, O.Soriano@gmail.com

Follow this and additional works at: <https://www.interscience.in/ijmie>

 Part of the [Manufacturing Commons](#), [Operations Research](#), [Systems Engineering and Industrial Engineering Commons](#), and the [Risk Analysis Commons](#)

Recommended Citation

Ferrouillat, S.; Bontemps, A.; Poncelet, O.; Gruss, J. A.; and Soriano, O. (2011) "Influence of Nanoparticle Shape Factor on Convective Heat Transfer of Water-Based ZnO Nanofluids. Performance Evaluation Criterion," *International Journal of Mechanical and Industrial Engineering*: Vol. 1 : Iss. 2 , Article 7. Available at: <https://www.interscience.in/ijmie/vol1/iss2/7>

This Article is brought to you for free and open access by Interscience Research Network. It has been accepted for inclusion in International Journal of Mechanical and Industrial Engineering by an authorized editor of Interscience Research Network. For more information, please contact sritampatnaik@gmail.com.

Influence of Nanoparticle Shape Factor on Convective Heat Transfer of Water-Based ZnO Nanofluids. Performance Evaluation Criterion

S. Ferrouillat¹, A. Bontemps², O. Poncelet³, O. Soriano⁴ & J. A. Gruss⁵

^{1&2}LEGI, Joseph Fourier University, Grenoble, France

^{3,4&5}LITEN/DTS/LETh, CEA, Grenoble, France

E-mail : Sebastien.ferrouillat@ujf-grenoble.fr, Jean-Antoine.Gruss@cea.fr

Abstract - The convective heat transfer of ZnO/water colloidal suspensions is investigated experimentally to appreciate the influence of two shapes of nanoparticles. Pressure drop and heat transfer coefficients have been measured at two different inlet temperatures (20, 50°C) in heating and/or cooling conditions at various flow rates ($200 < Re < 15,000$). The Reynolds and Nusselt numbers have been determined by using thermal conductivity and viscosity measured in the same conditions as those in tests. The results obtained are compared with classical correlations. An energetic Performance Evaluation Criterion (PEC) has been defined to compare heat transfer rate to pumping power.

Key words - Nanofluid, ZnO, Shape factor, Convective heat transfer, Performance energetic.

I. INTRODUCTION

Convective heat transfer enhancement has produced a considerable amount of research. This enhancement can be achieved by either active or passive ways. In this last case convective heat transfer can be improved by changing flow geometry, boundary conditions, or by modifying thermo physical properties of the fluid. Enhancing thermal conductivity allows the heat transfer coefficient to be increased. Among earlier efforts for enhancement of thermal conductivity the use of additives to liquids has been explored [1] and more recently, the introduction of solid microparticles or nanoparticles in a base fluid [2]. Engineered fluids with nanoparticles are commonly named “nanofluids”. Recent studies have also shown that if a thermal conductivity enhancement is possible by introducing nanoparticles in a base fluid it is necessary to add chemicals to stabilize the colloidal suspension which modify the thermophysical properties of the solution. Moreover, an increase of viscosity unfortunately occurs, leading to an extra pressure drop. Consequently, any gain in heat transfer could be compromised by an increase in pumping power.

To develop a nanofluid for heat transfer purposes, it is necessary to have a global approach to take into account not only the thermal conductivity enhancement but also the modification of other thermophysical properties. These properties, determined with the help of models, can have erroneous values and must be experimentally measured. On the other hand, it has been shown that, for a given concentration, nanoparticle

shape plays an important role both in thermal conductivity and viscosity modification [3].

In this paper, we studied the effect of nanoparticle shape on pressure drop and heat transfer coefficient for water based ZnO nanofluids (2 - 5 % wt) flowing in a horizontal pipe whose wall temperature was imposed. In a nanofluid some interaction can exist between the base fluid and the nanoparticle modifying the average physical properties. This is the reason why the thermophysical properties of these nanofluids have been experimentally determined. Then, we have studied the effects of fluid cooling and fluid heating in forced convective heat transfer and the results obtained have been compared with standard correlations. To appreciate the merits of nanofluids we have first considered heat transfer merits of the nanofluids by comparing measured Nusselt numbers to those of the base fluid and then the energetic merits by defining an energetic Performance Evaluation Criterion which allows us to compare heat transfer rate to pumping power.

II. NANOFUID PREPARATION AND CHARACTERIZATION

A. Nanofluid preparation

ZnO aqueous colloidal suspensions both polygonal and rod-like nanoparticles came from commercial sources, respectively from Nyacol (SN15ES) and Evonik (VP DISP ZnO 20 DW). The colloidal suspensions were dialyzed in cellulosic membranes (MWCO:14000 Dalton) for 1 week against deionised water in order to remove all the organics and salts. The

efficiency of the dialysis step was monitored by electrical conductivity measurements of the buffer water. Finally the solid percentages of nanoparticles in the nanofluids were adjusted by evaporation or dilution. The nanoparticles were characterized by transmission electron microscopy (TEM) performed on a JEOL 2000FX or on a High Resolution Scanning Transmission Electron Microscope (HRSTEM) Titan. It appears that the polygonal nanoparticles are massive as observed by means of HRSREM. It was also observed that they are perfectly crystalline (Figure 1 (a) and (b)).

The mass concentration was 4.4 % for Nyacol® and 5% for Evonik® based suspensions (Volume concentration: 0.82 % and 0.93 % respectively).

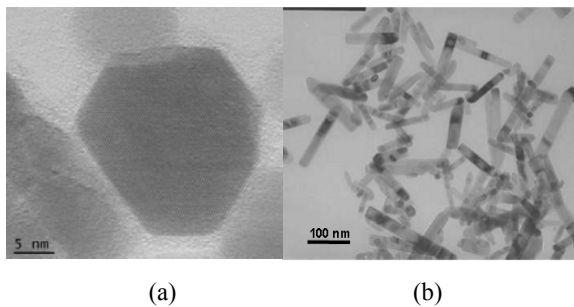

Fig. 1: (a) HRSTEM image of ZnO polygonal nanoparticles (Nyacol®) (b) TEM image of ZnO nanoparticles with a shape factor (Evonik®).

B. Nanofluid characterization

The density of the nanofluid is evaluated according to the standard formula

$$\rho = (1-\varphi) \rho_f + \varphi \rho_s \quad (1)$$

Where, φ is the volume fraction of the nanofluid.

ρ_f is the density of the base fluid

ρ_s is the density of the nanoparticles

For the use of nanofluids, this equation has been proved through an experimental validation by Vajjiha et al. [4]. In our case, it has been experimentally determined by weighing 100 ml of fresh Zinc Oxide suspension.

The specific heat for a mixture is given by the formula

$$Cp = (1-\varphi_w) Cpf + \varphi_w Cps \quad (2)$$

φ_w is the mass fraction of the nanoparticle,

Cpf is the specific heat of the base fluid

Cps is the specific heat of the nanoparticles

It has been also found appropriate for use with nanofluids.

To evaluate thermal conductivity of particle-fluid mixtures numerous theoretical studies have been conducted dating back to the classic work of Maxwell [5]. He has developed a model to determine the effective thermal conductivity for different volumetric loading of spherical particles embedded in a base medium. This model has been extended by Hamilton and Crosser [6] to non-spherical particles. However, Timofeeva et al. [3] have shown that their model does not explain the observed modification of thermal conductivity. Due to the lack of reliable models, especially for suspensions with non-spherical nanoparticles, thermal conductivity and dynamic viscosity have been measured. Thermal conductivity has been measured using a thermal property analyzer (model Lambda system 1, F5 Technologie GmbH) based on the transient hot wire method. The accuracy was carefully checked with pure water. Results are presented in Figure 2 as a function of temperature. It is observed that the thermal conductivity of the nanofluid is slightly greater than the water conductivity. Thermal conductivity increases more slowly than that of water with temperature. This could be due to the thermal conductivity of ZnO which decreases with temperature [7] and compensates for water conductivity augmentation. However, the enhancement is lower than that predicted by the Hamilton-Crosser relationship [6] due probably to interface effects.

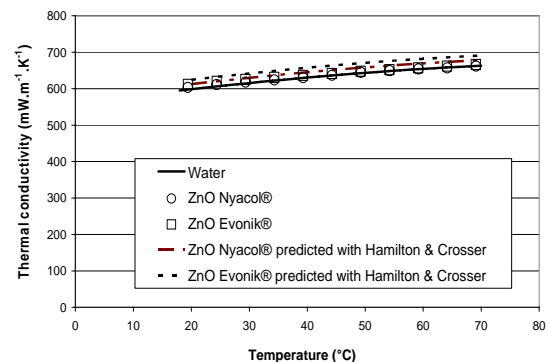

Fig. 2 : Thermal conductivity of ZnO suspensions: polygonal nanoparticles (Nyacol®) and nanoparticles with a shape factor (Evonik®).

Dynamic viscosity was measured using a Brookfield rotational-type viscometer. The fluids are Newtonian in the shear rate range of 100 – 1000 s⁻¹. Obtained results as a function of temperature are presented Figure 3 for 1000 s⁻¹ shear rate. For ZnO/water suspensions, viscosity of nanofluids with rod-shaped nanoparticles is slightly less than that with polygonal particles (Figure 3).

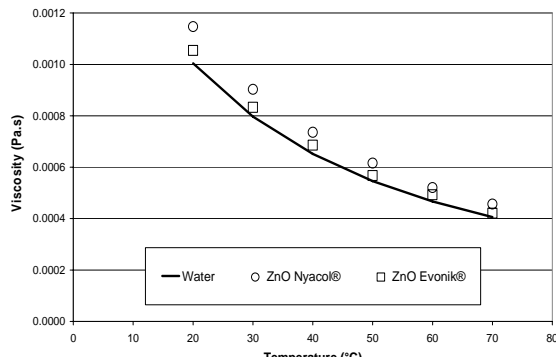

Fig. 3 : Thermal conductivity of ZnO suspensions: polygonal nanoparticles (Nyacol®) and nanoparticles with a shape factor (Evonik®).

III. EXPERIMENTAL APPARATUS AND DATA REDUCTION

A. Test loop and test section

The detailed description of the experimental apparatus has already been done previously [8]. The main features are recalled hereafter. Flow loop used for pressure drop and convective heat transfer coefficient measurements with fixed wall temperature boundary conditions is shown schematically in figure 4.

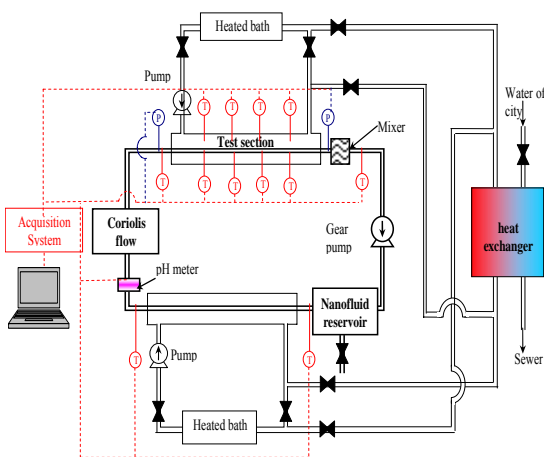

Fig. 4 : Schematic of convective loop experimental facility

After injection in the reservoir tank, the nanofluid, with specified concentration, was circulated using a gear pump. Assuming that nanofluids are considered as homogeneous fluids, the flow rate was measured by a Coriolis flow meter. The pressure drop was measured directly by three differential strain-gauge pressure transducers operating over a range of 0-1620 kPa.

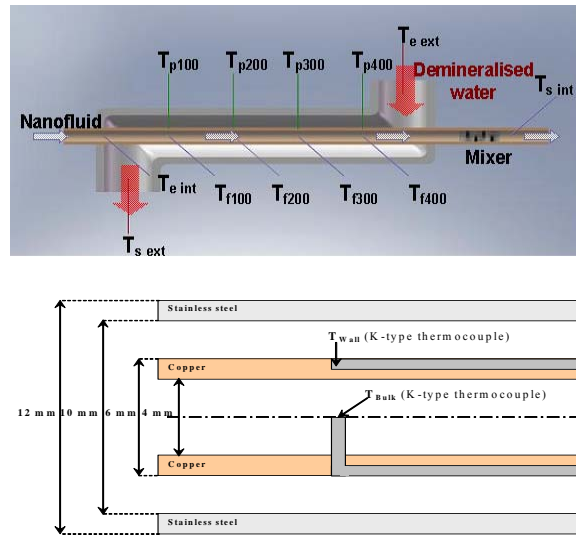

Fig. 5: Test section. Scheme of the thermocouple positioning.

The test section (figure 5) consisted of a 0.5 m long tube-in-tube heat exchanger, the tested nanofluid flowing into the 4 mm diameter and 1 mm thick inner copper tube (CuA1) and heating or cooling water flowing into a 10 mm diameter and 1 mm thick stainless steel annular tube. The test section was preceded by a 0.5 m (125 diameters) adiabatic section.

The nanofluid was circulated inside the inner tube (primary loop) with a temperature varying between 15 to 90 °C. To observe the potential influence of the transverse temperature gradient, the water temperature was varied within the same range allowing us to change the temperature difference between the fluid and the wall. The fluid could be heated or cooled thanks to various valves in the experimental loop, and then the gradient direction could be modified. After passing through the test section, the nanofluid entered a heat exchanger in which water was used as a cooling or heating fluid depending on nanofluid heating or cooling tests. For both primary and secondary loops, the temperature was controlled using two thermostatic baths (Polystat® 37, Fischer Scientific) and a second heat exchanger.

The entire test section was insulated with polyurethane foam (Armaflex) in order to minimize heat loss.

B. Temperature measurement

Two (K-type) thermocouples were inserted into the flow at the inlet and outlet of the test section for measuring bulk temperatures of nanofluid. In order to

increase the accuracy of the outlet temperature measurement for laminar flow, a static mixer was inserted downstream of the test section. To record the temperature at the outer surface of the copper tube and the bulk temperature, four (K-type) thermocouples were brazed on the inner tube wall and four (K-type) thermocouples were inserted into the inner tube at equally spaced 10 cm distances (Figure 5). The thermocouples were calibrated before the tests and had a maximum accuracy of ± 0.1 °C. All the data were recorded by an Agilent 34970A data acquisition unit.

To determine inner wall temperature, the thermal resistance due to conduction through the tube was taken into account. To determine inner flow bulk temperature, T_{bi} , we added a corrective term by taking into account the fin effect due to the intrusive thermocouples in writing an energy balance between forced convective flow perpendicular to the thermocouple and conduction in the thermocouple between its extremity and the wall [8].

C. Data reduction

The heat flow rate Q (W) was determined from the mass flow rate m (kg/s) and the inlet and outlet temperatures of the fluid:

$$Q = m C_p (T_{in} - T_{out}) \quad (3)$$

The internal heat transfer coefficient h_i between the nanofluid and the wall was derived from the following expression of the heat flow rate:

$$Q = (R_w + 1/h_i)^{-1} S (T_w - T_b) \quad (4)$$

Where: S is the heat exchange area (m^2),

T_w is the average external wall temperature of the four K-type thermocouples brazed on the inner tube (K),

T_b is the average internal bulk temperature deduced from the four K-type thermocouples inserted into the inner tube (K),

R_w is the thermal resistance of the copper tube wall ($m.K.W^{-1}$).

Q being known, the internal heat transfer coefficient h_i ($W.m^{-2}.K^{-1}$) can thus be calculated from

$$h_i = (S(T_w - T_b)/Q - R_w)^{-1} \quad (5)$$

Once the experimental heat transfer coefficient h_i is determined, the experimental Nusselt number is deduced and must be compared with the value obtained experimentally with pure water, which is the base fluid. This comparison is done by plotting the ratio of the Nusselt number measured with the nanofluid N_{unf} and the Nusselt number measured with pure water N_{uf} . In each case, the Reynolds number was deduced from the mass flow rate measurement.

Using three differential strain-gauge pressure transducers, the pressure drop measurement enables the friction factor (or Darcy coefficient) to be deduced with the following expression:

$$f_{exp} = 2 \Delta P (d/L) \rho S p^2 / m^2 \quad (6)$$

Where ΔP (Pa) is the pressure drop, d (m) the internal tube diameter, L (m) the tube length and $S p^2$ (m^2) the tube cross section.

IV. EXPERIMENTAL RESULTS AND DISCUSSION

A. Pressure drop

A preliminary test was conducted with water for pressure loss measurements. Three measurement conditions were studied. The first (not presented here) is an isothermal condition, where the two fluids are at the same temperature (20 °C or 50 °C). The second is a cooling condition for which the external water is at 20°C and the nanofluid at 50°C. The third is a heating condition for which the external water is at 50 °C and the nanofluid at 20 °C.

The results obtained (Figure 6) were compared with classical relationships. In laminar flow regime ($Re < 2300$), the following Poiseuille equation is used in the calculations:

$$f = 64/Re \quad (7)$$

In turbulent flow regime, the Blasius equation is used:

$$f = 0.316 Re^{-1/4} \quad (8)$$

In heat transfer conditions, the Poiseuille and the Blasius laws are followed provided that the experimental Darcy coefficient is modified by using a corrective factor as indicated by Petukhov [9]:

$$f = f_{exp} (\mu_w/\mu)^n \quad (9)$$

Where μ_w is the viscosity of the fluid near the wall and μ is the viscosity at the bulk temperature.

The n exponent was experimentally found to be equal to the following:

- For heating conditions, $n = -0.58$ for laminar flow and $n = -0.25$ in turbulent flow;
- For cooling conditions, $n = -0.50$ for laminar flow and $n = -0.25$ for turbulent flow.

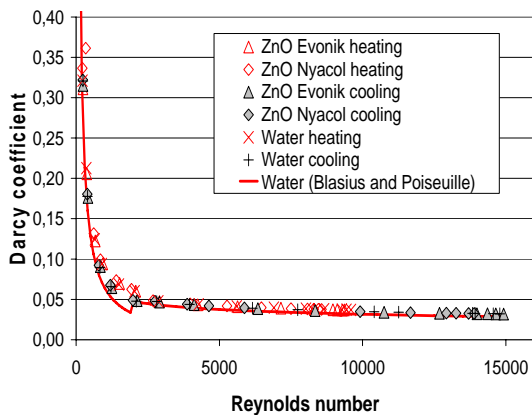

Fig. 6 : Evolution of the Darcy coefficient as a function of Reynolds number. Full line refers to Poiseuille ($Re < 2300$) and Blasius ($Re \geq 2300$) relations

As a first observation, in laminar flow regime, the results followed Poiseuille classical laws with demineralised water at $Re < 1000$. However, for $1000 < Re < 2300$, the Poiseuille law under-predicts the experimental values. This deviation may be associated with the presence of the four thermocouples inserted into the inner tube. These thermocouples may generate turbulence for a Reynolds number lower than 2300 and induce an increased pressure drop and thus an increase of the Darcy coefficient. As a result, a smooth transition between laminar and turbulent regime is observed compared to the sudden change of pressure drop at the turbulence onset.

The pressure drop of nanofluid with rod-like nanoparticles is smaller than the one with polygonal particles. This could be due to the density of the rod-like nanoparticle suspensions which is greater than the one of spherical nanoparticles.

B. Heat transfer coefficient and Nusselt number

Before determining the convective heat transfer coefficient of a nanofluid, the apparatus was calibrated using pure demineralised water in heating and cooling conditions. Then, heat transfer coefficients of the two water/ZnO nanofluids (with polygonal and rod-like nanoparticles) were determined and Nusselt numbers deduced. Fig. 7 shows Nusselt numbers obtained with water and the 2 nanofluids as a function of the Reynolds number. Two distinct groups of values are observed, one in heating conditions, the other in cooling conditions.

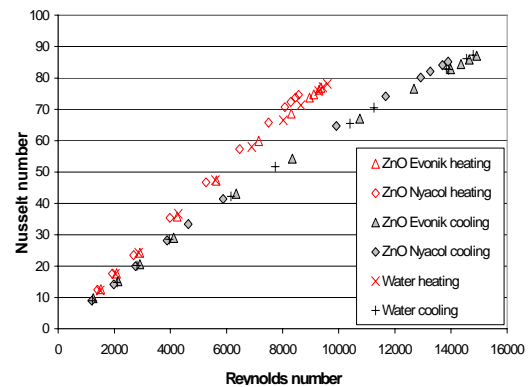

Fig. 7: Experimental Nusselt number as a function of Reynolds number

The experimental results indicate that there is an increase in Nusselt number of nanofluids compared to that of water in both groups. To quantify more precisely this increase, we have reported the ratio Nu_{nf}/Nu_f where Nu_{nf} and Nu_f are the Nusselt numbers for the nanofluid and water respectively. In Figure 8, it is observed that Nusselt number ratios are shared in two groups: one for polygonal nanoparticles suspensions (8 % increase), the other for rod-like nanoparticles suspensions (3% increase). This higher augmentation for polygonal particles could be due to the dynamic viscosity of the rod-like ZnO suspension which is lesser than the one of polygonal ZnO suspensions. As a simplistic approach, using the Dittus-Boelter correlation [10], in turbulent regime for identical Reynolds numbers the ratio Nu_{nf}/Nu_f is function of $\mu_{nf}^{0.3}$. Considering viscosity values this ratio is higher for polygonal particles than rod-like particles.

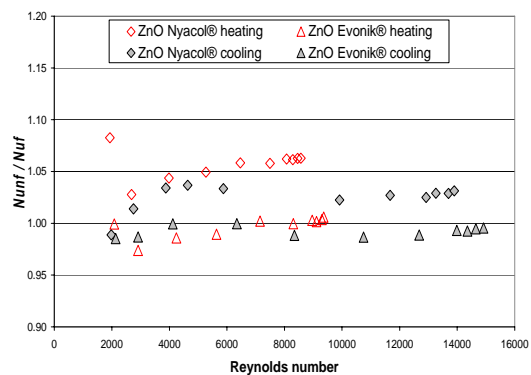

Fig. 8: Evolution of the measured ratio Nu_{nf}/Nu_f as a function of Reynolds number of Water/ZnO suspensions.

These results have been interpreted by using the classical Gnielinski correlation valid for $Re > 2300$ in transition and turbulent regime in heating and cooling conditions [11] and given by:

$$Nu = \frac{(f/8)(Re-1000)Pr}{1+12.7\sqrt{(f/8)}(Pr^{2/3}-1)} \left(\frac{Pr}{Pr_w}\right)^{0.11} \left[1 + \left(\frac{d}{L}\right)^{2/3}\right] \quad (10)$$

Pr and Pr_w are the Prandtl numbers calculated at the fluid bulk temperature and at the inner wall temperature respectively. The bulk temperature is an average of the inlet and outlet fluid temperatures.

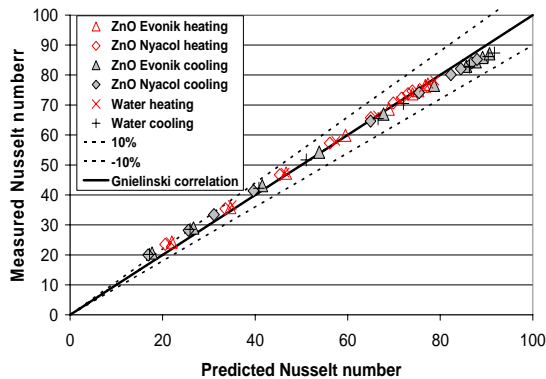

Fig. 9: Comparison of measured Nusselt numbers and Nusselt numbers deduced from the Gnielinski correlation.

It can be seen that experimental data correspond well with the predictions of the correlation to within $\pm 10\%$ (Figure 8). This conclusion has already been drawn by Williams et al. [12]. It must be noted that Gnielinski gives a $\pm 20\%$ range of validity for his correlation.

V. OPTIMISATION AND ENERGETIC CRITERION

There are several ways to characterise the energetic or thermal performance of a fluid flowing in a specific device.

- The first one is to only consider the heat transfer coefficient or the Nusselt number enhancement compared with a reference one. In the preceding paragraph we have seen that for Nyacol® suspensions a slight enhancement is observed whereas no significant improvement is brought with Evonik® suspensions.
- As heat transfer and pressure drop are the most critical factors, they can be compared through several approaches: (i) the heat transfer per unit of

pressure drop represented by the ratio of the j -Colburn factor by the f -friction factor (or Darcy coefficient) [13] or (ii) performance criteria allowing a device to be compared with a reference device by defining the following JF factor [14]:

$$JF = \frac{j/j_R}{(f/f_R)^{1/3}} \quad (11)$$

Parameters with the R subscript are those of the reference device. This JF factor was used to compare two heat exchangers having a different geometry, it could be used to compare two heat exchangers with the same geometry but with two different fluids.

- Rather than the two preceding approaches we have preferred to use the PEC (Performance Evaluation Criterion) defined below and based on an energetic global approach. It is defined as the ratio of heat transferred to the required pumping power in the test section:

$$PEC = \frac{m.C_p(T_{out} - T_{in})}{Q_v \Delta P} \quad (12)$$

Where, Q_v is the volumic flow rate (m^3/s), T_{in} and T_{out} the tube inlet and outlet temperatures and ΔP the pressure drop (Pa).

This criterion is directly related to gains and losses of energy in an industrial plant. As for heat transfer where Nusselt numbers have been compared with that of water, we have plotted on the same figure the PEC_{nf}/PEC_f ratio for the two nanofluids (Figure 10).

In a previous experimental work with commercial SiO_2 nanoparticles [8] the PEC values were found to be less than those of water indicating that the energy budget is unfavourable. For ZnO/water nanofluids, it appears that the PEC values are close to unity for nanoparticles with a shape factor.

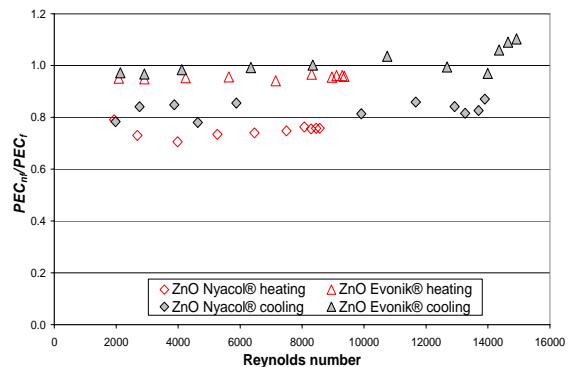

Fig. 10 : Evolution of ratios of Performance Evaluation Criteria as a function of Reynolds number

VI. CONCLUSIONS

Experiments have been conducted to study the influence of the shape factor of nanoparticles in colloidal suspensions in order to determine the energetic performance of these fluids. Two nanofluids have been studied with water as base fluid. Polygonal and rod-like ZnO nanoparticles were used in the colloidal suspensions. Thermal conductivity has been measured for the two nanofluids in conditions close to the experimental ones. Dynamic viscosity as a function of temperature has also been measured. Convective heat transfer has been studied for the 2 nanofluids flowing inside a horizontal tube in cooling and heating conditions. From the measurements of pressure drop and heat transfer coefficients Darcy coefficients and Nusselt numbers have been deduced. Finally, the energetic performances have been characterized by using the *PEC* (Performance Evaluation Criterion).

From these measurements, these general conclusions can be drawn:

- Measurements of physical properties of nanofluids must be carried out in conditions close to the experimental ones
- If the measured thermal and physical properties are taken into account to calculate the dimensionless numbers, the existing correlations reproduce the convective heat transfer and the pressure loss in tubes within their range of validity.
- From an energy point of view, it is difficult to obtain a *PEC* higher than that of water. It seems that with nanofluids with nanoparticles whose shape factor is greater than 3 this objective could be reached, even exceeded.

REFERENCES

- [1] Bergles, A.E., 1969, Survey and evaluation of techniques to augment convective heat and mass transfer, *Progress in Heat and Mass Transfer*, 1, 331-424
- [2] Choi, S.U.S., Enhancing thermal conductivity of fluids with nanoparticles, in: Siginer, D.A., Wang, H.P., (Eds), in: *Development and applications of non-newtonian flows*, ASME, FED, vol. 231MD, 66, 99-105.
- [3] Timofeeva, E.V., Rotbort, J.L., Singh, D., 2009, Particle shape effects on thermophysical properties of alumina nanofluids, *J. Applied Physics*, 106, 014304, 1-10
- [4] Vajjha, R.S., Das D.K., Mahagaonkar, B.M., 2009, Density measurement of different nanofluids and their comparison with theory, *Petroleum Science and Technology*, 27(6), 612-624
- [5] Maxwell, J.C., 1981, 2nd ed., *A Treatise on Electricity and Magnetism*, vol. 1, Clarendon press, Oxford.
- [6] Hamilton, R.L., Crosser, O.K., 1962, Thermal conductivity of heterogeneous two-component systems, *I&EC Fund.* 1, 3, 187-191
- [7] Klingshim, C.F., Meyer, B.K., Waag, A., Hoffmann, A., Geurts, J., 2010, *Zinc Oxide. From fundamental properties towards novel applications*. Springer-Verlag, Berlin, Heidelberg.
- [8] Ferrouillat, S., Bontemps, A., Ribeiro, J.-P., Gruss, J.-A., Soriano, O., 2011, Hydraulic and heat transfer study of SiO₂/water nanofluids in horizontal tubes with imposed wall temperature boundary conditions, *Int. J. Heat Fluid Flow*, 32, 424-439.
- [9] Petukhov, B.S., 1970, Heat transfer and friction in turbulent pipe flow with variable physical properties, in : Irvine, T.F., Hartnett, J.P., (Eds). *Advances in Heat Transfer*, 6, 503-564.
- [10] Dittus, F.W., Boelter, L.M.K., 1930, *Heat Transfer in Automobile Radiators of the Tubular Type*, University of California publications of engineering, 2(13), 443-461.
- [11] Gnielinski, V., 1976, New equations for heat and mass transfer in turbulent pipe and channel flow (Translated from German). *Int. Chem. Engineering*. 16, 2, 359 – 368
- [12] Williams, W., Buongiorno, J., Hu, L.-H., 2008, Experimental investigation of turbulent convective heat transfer and pressure loss of alumina/water and zirconia/water nanoparticle colloids (nanofluids) in horizontal tubes. *Trans. ASME, J. Heat Transfer*. 130, 042412 1-7.
- [13] Colburn, A.P., 1933, A method of correlating forced convection heat transfer data and a comparison with fluid friction, *Trans. AIChE*, 29, 174
- [14] Yun, J.-Y., Lee, K.-S., 2000, Influence of design parameters on the heat transfer and flow friction characteristics of the heat exchanger with slit fins, *International Journal Heat Mass Transfer*, 43, 2529-2539.

