

July 2012

## Proposed design for circular antenna and half ring antenna for UWB Application

Minal Kimmatkar

*Department of Electronics Engg. Y.C.C.E. Nagpur, MS India, minalkimmatkar@gmail.com*

P. T. Karule

*Department of Electronics Engg. Y.C.C.E. Nagpur, MS India, ptkarule@rediffmail.com*

P. L. Zade

*Department of Electronics Engg. K.I.T.S, Ramtek, MS, India, zadepl@yahoo.com*

P. S. Ashtankar

*Department of Electronics Engg. K.I.T.S, Ramtek, MS India, psashtankar@gmail.com*

Follow this and additional works at: <https://www.interscience.in/ijeee>



Part of the [Power and Energy Commons](#)

---

### Recommended Citation

Kimmatkar, Minal; Karule, P. T.; Zade, P. L.; and Ashtankar, P. S. (2012) "Proposed design for circular antenna and half ring antenna for UWB Application," *International Journal of Electronics and Electrical Engineering*: Vol. 1 : Iss. 1 , Article 8.

Available at: <https://www.interscience.in/ijeee/vol1/iss1/8>

This Article is brought to you for free and open access by Interscience Research Network. It has been accepted for inclusion in International Journal of Electronics and Electrical Engineering by an authorized editor of Interscience Research Network. For more information, please contact [sritampatnaik@gmail.com](mailto:sritampatnaik@gmail.com).

## ***Proposed design for circular antenna and half ring antenna for UWB Application***

**Minal Kimmatkar , P. T. Karule, P. L. Zade , P. S. Ashtankar**

Department of Electronics Engg. Y.C.C.E.

Nagpur, MS India, Department of Electronics Engg. K.I.T.S,  
Ramtek, MS India

E-mail [minalkimmatkar@gmail.com](mailto:minalkimmatkar@gmail.com), [ptkarule@rediffmail.com](mailto:ptkarule@rediffmail.com), [zadepl@yahoo.com](mailto:zadepl@yahoo.com),  
[psashtankar@gmail.com](mailto:psashtankar@gmail.com)

**Abstract**—In this paper, Ultra wideband planar circular patch and half circular ring patch antennas are proposed. These newly simulated structures are proposed for fabrication. The antennas are suitable for operating frequency of 7.5 GHz. It is shown that return loss of the both the antennas at 7.5 GHz is better than -10 dB. The VSWR obtained is less than 2. The half ring patch antenna is found to have the compact size and more bandwidth as that of circular patch antenna. HFSS11 is used for the simulation. From HFSS11 simulations, dimensions of antennas are chosen for better performance. Details of the proposed antenna design and measured results are presented in this paper

**Keywords**- Ultra-wide band, circular antenna, half ring antenna

### I. INTRODUCTION

FCC( Federal communications commission) allocated a block of radio spectrum from 3.1GHz to 10.6 GHz for UWB operations [1].UWB systems can support more than 500 Mbps data transmission within 10m[1]. Compact size, low-cost printed antennas with Wideband and Ultra wideband characteristic are desired in modern communications. The Ultra wide band antennas can be classified as directional and omni-directional antennas [3]. A directional antenna have the high gain and relatively large in size. It has narrow field of view. Whereas the omni-directional antenna have low gain and relatively small in size. It has wide field of view as they radiates in all the directions [3].

The UWB antennas have broad band. There are many challenges in UWB antenna design. One of the challenges is to achieve wide impedance bandwidth. UWB antennas are typically required to attain a bandwidth, which reaches greater than 100% of the center frequency to ensure a sufficient impedance match is attained throughout the band such that a power loss less than 10% due to reflections occurs at the antenna terminals. Various planar shapes, such as square, circular, triangular, and elliptical shapes are analyzed and reported. Compared with monopole based planar antennas, the design of ultra wide band circular ring type antennas is difficult because of effect of the ground Plane. The bandwidth of the microstrip antenna can be enhanced by modifying the ground plane [6]. Many designers have tried various ways to improve the structure of the traditional circular antennas, and many valuable

results have been obtained. Circular ring and half circular ring antennas are proposed in this paper.

#### A. Important properties of UWB

The following properties are required for the UWB antennas:

- 1) *Linear phase and constant group delay in directivity:* If the group delay is not constant, the pulse waveform is spread out in the time domain.
- 2) *Low return loss over ultra wide bandwidth:* If there are mismatches both at the antenna end and the circuitry end, the overall dispersion characteristic is much degraded due to the multipath within the feeding cable.
- 3) *Constant directivity over ultra wide bandwidth:* The variation of the directivity according to the frequency results in the ripples of the frequency transfer function in some citation direction. The dispersion characteristic is then degraded.

#### B. Fundamental principles to achieve UWB

There are two fundamental principles to achieve the broadband or UWB property of the antennas [9]:

- 1) *Self similarity antenna:* A self similarity antenna is with the constant electric shape over the wide frequency bandwidth. Here, the electric shape means the shape described in the dimension of the wavelength. A biconical antenna, a bow-tie antenna, a discone antenna, an equi-angular spiral antenna are the examples of this class.
- 2) *Self complementary antenna:* A self complementary antenna is usually composed of planar conductor(s), and its complementary structure is identical to the original structure. Here, complementary structure is obtained by replacing the conductor and the non-conductor parts in the plane. Among the self complementary antennas, the log-periodic antenna is well known.

This paper implements circular and half circular ring antenna. The ground plane is modified in order to enhance the bandwidth. Good results are obtained for both the antennas in terms of S11 parameter and VSWR. Antennas are suitable for UWB communication. The s11 of -10dB is found to satisfy over the band of 1.42 GHz and 7.52 GHz for circular and half ring patch respectively. The circular antenna shows the S11 and VSWR of -12.4 dB and 1.63

respectively at the frequency of 7.5 GHz. The half circular ring patch antenna shows S11 and VSWR of -28 dB and 1.1 respectively at 7.5 GHz.

II. ANTENNA CONFIGURATION AND DESIGN

The geometry, parameters, top and bottom views for a prototype of the proposed planar circular patch antenna are shown in Figure 1. The antenna consists of circular patch, 50 ohm micro strip line, a probe connector and ground. Circular patch is printed on the top side of the substrate. The planar circular patch is parallel to x-y plane; micro strip line is along the y-axis. The circle of radius R of dimension 5.24 mm is given. The defected ground structure is offered with the slot of 28.1mm X 10 mm.

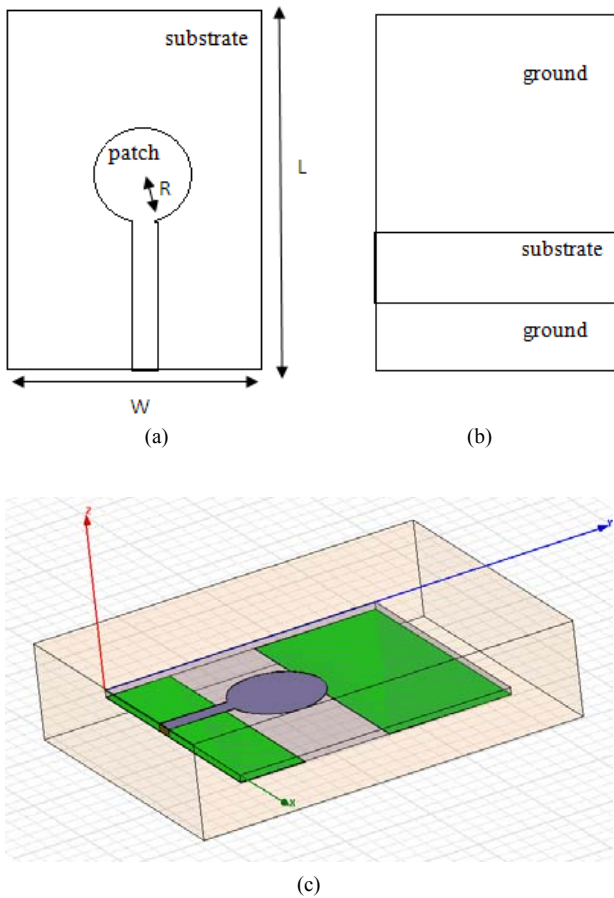

Figure 1. Geometry of circular patch for UWB communication (a)Top View (b) Bottom View (C) Design geometry

Top view, bottom view and design geometry of circular patch antenna are indicated in figure 1. The proposed antenna was designed on a Rogers RT/duroid 5880TM substrate with dielectric constant  $\epsilon_r = 2.2$  and height of the substrate is  $h = 0.794$  mm. The substrate has length  $L = 32$ mm and width  $W = 28.1$ mm. The substrate is mounted on ground of 32 mm length and 28.1 mm width.

The dimensions of antenna are calculated from the formula as shown in table 1.

Table 1  
Antenna parameters calculations equation [2]

Resonant frequency $(f_r)_{110}$ ; dominant mode $TM_{110}$ mode; (no fringing)	$(f_r)_{110} = \frac{1.8412}{2\pi a \sqrt{\epsilon_r} \sqrt{\mu_0 \epsilon_0}}$
Resonant frequency $(f_{rc})_{110}$ ; dominant mode $TM_{110}$ mode; (with fringing)	$(f_{rc})_{110} = \frac{1.8412}{2\pi a_e \sqrt{\epsilon_r} \sqrt{\mu_0 \epsilon_0}}$
Effective radius $a_e$	$a_e = a \left\{ 1 + \frac{2h}{\pi a \epsilon_r} \left[ \ln \left( \frac{\pi a}{2h} \right) + 1.7726 \right] \right\}^{1/2}$
Physical radius $a$	$a = \frac{F}{\left\{ 1 + \frac{2h}{\pi \epsilon_r F} \left[ \ln \left( \frac{\pi F}{2h} \right) + 1.7726 \right] \right\}^{1/2}}$ $F = \frac{8.791 \times 10^9}{f_r \sqrt{\epsilon_r}}; (h \text{ in cm})$
Directivity $D_o$	$D_o = \frac{(k_0 a_e)^2}{120 G_{rad}}$

The half ring patch antenna has the compact size as compared to circular antenna. The geometry, parameters, front and side views for a prototype of the proposed half ring patch are shown in Figure 2. The antenna consists of half circular ring patch, 50 ohm micro strip line, a probe connector and ground. Half circular ring patch is printed on the top side of the substrate. The circular arm has thickness of 2 mm. The radius R1 and radius R2 of dimensions 5.24 mm and 3.24 mm are given. The ground plane has the slot of 28.1mm X 6.9 mm.

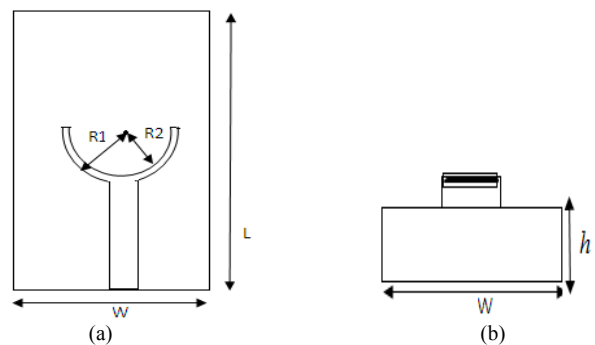

Proposed design for circular antenna and half ring antenna for UWB Application

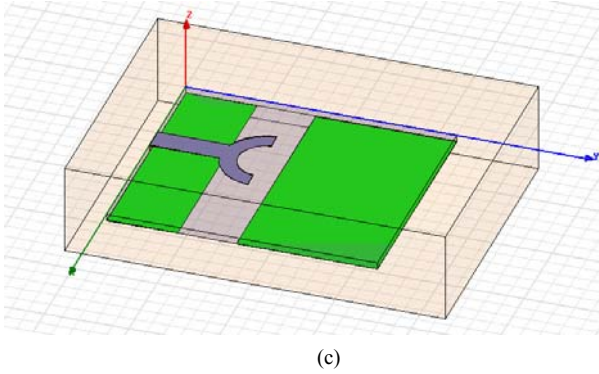

Figure 2. Geometry of modified half ring antenna (a) Top view (b) front view (c) Design geometry

The proposed antenna was designed on a Rogers RT/duroid 5880TM substrate with dielectric constant  $\epsilon_r = 2.2$  and height of the substrate is  $h = 0.794$  mm. Both the substrate and ground are of length  $L = 32$  mm and width  $W = 28.1$  mm. The substrate is mounted on ground of 32 mm length and 28.1 mm width.

III. RESULTS

Figure 3 and figure 4. Shows 3-D polar plots for the gains of the circular patch and half ring patch. The former antenna has the gain of 4.7 dB and later antenna has 4.8 dB gain.

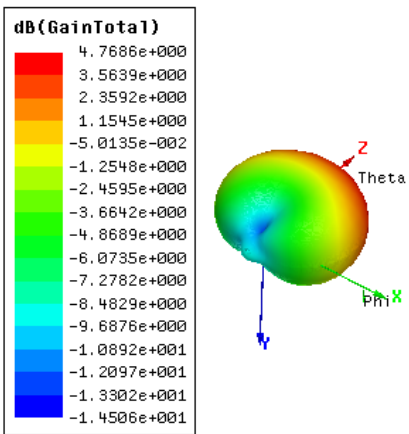

Figure 3. Gain of circular antenna 7.5 GHz

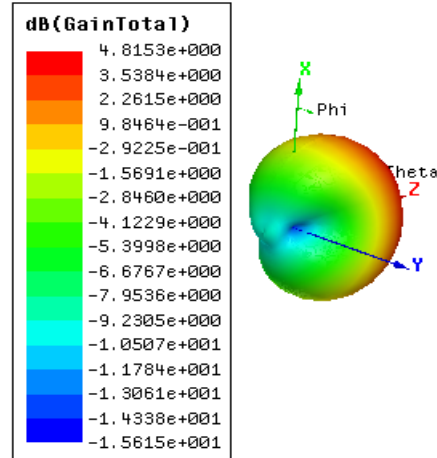

Figure 4. Gain of half ring antenna at 7.5 GHz

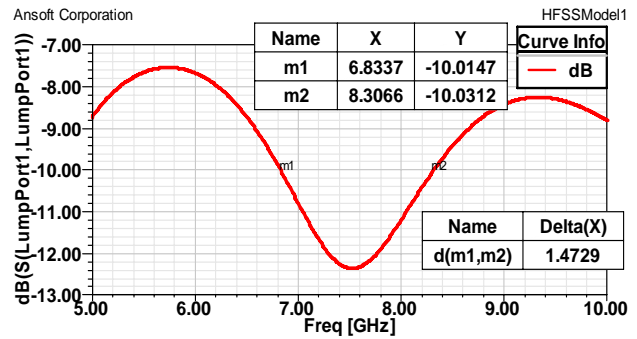

Figure 5. S11 of circular patch antenna

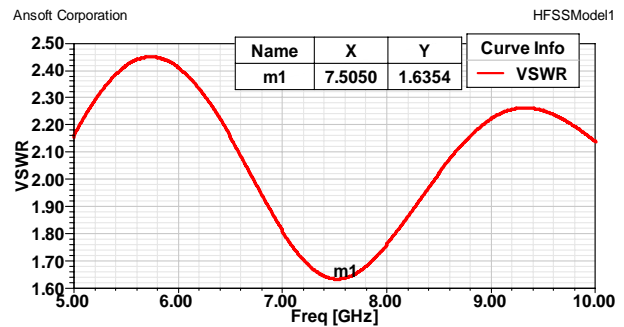

Figure 6. VSWR of circular patch antenna

Proposed design for circular antenna and half ring antenna for UWB Application

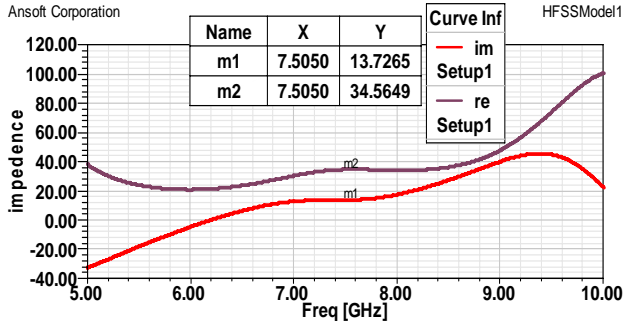

Figure 7. Z- parameter of circular patch antenna

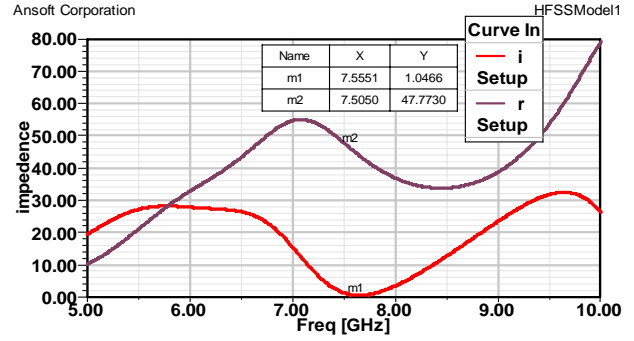

Figure 10. Z- parameter of half ring patch antenna

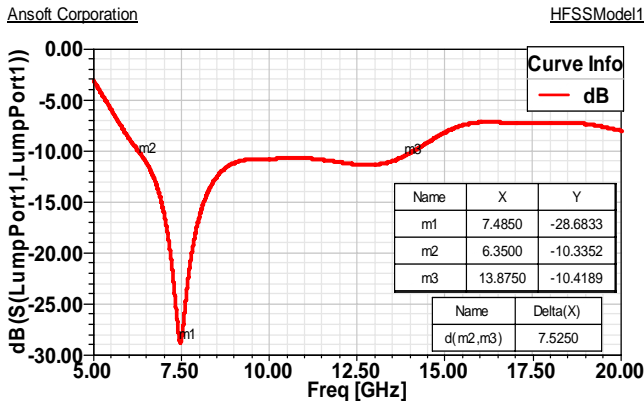
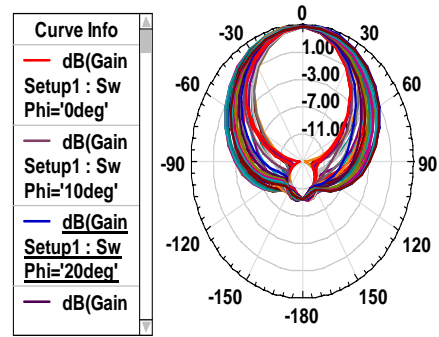

Figure 8. S11 of Half circular ring patch antenna



(a)

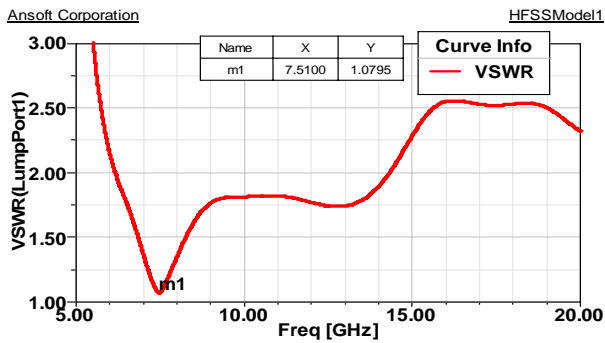
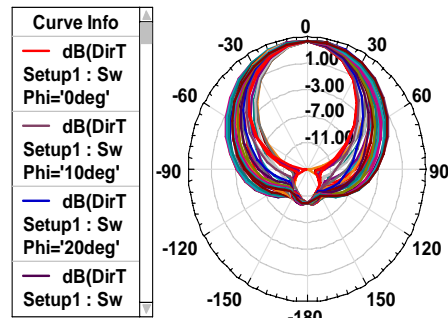

Figure 9. VSWR of Half ring patch antenna



(b)

Figure 11. Radiation pattern of circular patch antenna at 7.5GHz

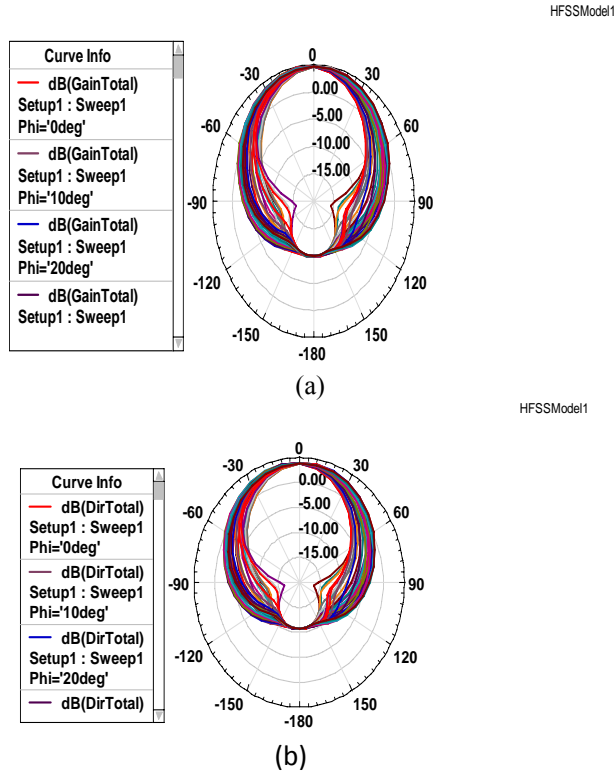

Figure 12. Radiation pattern of half circular ring patch antenna at 7.5GHz

#### IV. CONCLUSION

In this paper, the circular patch antenna and half ring patch antenna are simulated using HFSS. The proposed antennas have the advantages of small size, easy fabrication and simple construction. The simulated results of proposed antenna for return loss is less than -10 dB and VSWR is n less than 2. The bandwidth of Circular and half ring patch is found to have bandwidth of 1.47 GHz and and 7.52GHz. The gain of former antenna is 4.7 dB and that of later one is 4.8 dB. It shows that the antennas can be good candidates for ultra wide band application at the operating frequency of 7.5 GHz.

#### V. REFERENCES

- [1] Chiachin chang, Fujo watanable and Hiroshi Inamura, “ Potential of UWB Technology For the Next Generation Wireless communications”, IEEE Ninth International Symposium on spread spectrum Techniques and Applications, pp.422-429,2006.
- [2] C. Balanis, Antenna Theory: Analysis and Design, New York, John Wiley & Sons, Inc., 1997.
- [3] Hans Gregory Schantz, “Introduction To Ultra Wide Band Antennas,” IEEE 2003
- [4] W. Stutzman, G. Thiele, Antenna Theory and Design, New York, John Wiley & Sons, Inc., 1998.
- [5] Ahmad A. Sulaiman, Mohamad Z. M. Zani, Mohd H. Jusoh , Noor H. Baba , Robi’atun A. Awang , Mohd F. Ain , “Circular Patch Antenna on Metamaterial”, European Journal of Scientific Research, pp.391-399 , 2010.
- [6] N. Prombutr, P. Kirawanich, and P. Akkaraekthalin, “Bandwidth enhancement of UWB micro strip antenna with a modified ground plane”, International Journal of Microwave Science and Technology Volume 2009.
- [7] D. Xi. , L. H. Wen, Y. Z. Yin, Z. Zang and Y. N. Mo, “A compact dual inverted c-shaped slots antenna for WLAN applications”, Progress In Electromagnetics Research Letters, Vol. 17, 115-123, 2010
- [7] H. Ebrahimian and M. Ojaroudi , “Design of a novel ultra-wideband printed monopole antenna for use in a circular cylindrical microwave imaging system”
- [8] S. Barbarino , “UWB circular slot antenna provided with an inverted-l notch filter for the 5Ghz WLAN band,” Progress In Electromagnetics Research, PIER 104, 1-13, 2010.
- [9] M.C. Greenberg, L.L. Virga, “Characterization and design methodology for the dual exponentially tapered slot antenna” IEEE Antennas and Propagation Society International Symposium, vol.1, pp. 88 - 91, July 1999, Atlanta, GA.
- [10] Nader Behdad, Kamal sarabandi, “ A compact antenna for Ultrawide- Band applications”, IEEE Transactions on antennas and propagation, vol. 53, no. 7, July 2005.